

# AVIAN™

# SMART™



TECHNOLOGY

**Spektrum™ AVIAN™ SMART ESCs**

---

**Spektrum™ AVIAN™ SMART  
Geschwindigkeitsregler**

---

**Variateurs ESC Spektrum™ AVIAN**

---

**SMART ESC SPEKTRUM™ AVIAN™**

---

**HORIZON**  
H C B B Y



**SPEKTRUM®**

## NOTICE

All instructions, warranties and other collateral documents are subject to change at the sole discretion of Horizon Hobby, LLC. For up-to-date product literature, visit [horizonhobby.com](http://horizonhobby.com) or [towerhobbies.com](http://towerhobbies.com) and click on the support or resources tab for this product.

## Meaning of Special Language

The following terms are used throughout the product literature to indicate various levels of potential harm when operating this product:

**WARNING:** Procedures, which if not properly followed, create the probability of property damage, collateral damage, and serious injury OR create a high probability of superficial injury.

**CAUTION:** Procedures, which if not properly followed, create the probability of physical property damage AND a possibility of serious injury.

**NOTICE:** Procedures, which if not properly followed, create a possibility of physical property damage AND a little or no possibility of injury.



**WARNING:** Read the ENTIRE instruction manual to become familiar with the features of the product before operating. Failure to operate the product correctly can result in damage to the product, personal property and cause serious injury.

This is a sophisticated hobby product. It must be operated with caution and common sense and requires some basic mechanical ability. Failure to operate this Product in a safe and responsible manner could result in injury or damage to the product or other property. This product is not intended for use by children without direct adult supervision. Do not attempt disassembly, use with incompatible components or augment product in any way without the approval of Horizon Hobby, LLC. This manual contains instructions for safety, operation and maintenance. It is essential to read and follow all the instructions and warnings in the manual, prior to assembly, setup or use, in order to operate correctly and avoid damage or serious injury.

**Age Recommendation: Not for children under 14 years.**  
**This is not a toy.**

**NOTICE:** This product is only intended for use with unmanned, hobby-grade, remote-controlled vehicles and aircraft. Horizon Hobby disclaims all liability outside of the intended purpose and will not provide warranty service related thereto.

# Contents

Wiring Diagram.....	5
Throttle Signal .....	6
Installation and Wiring .....	7
ESC/Radio Calibration .....	7
Stick Programming .....	8
Programming Options Descriptions .....	11
Programming with the SMART Programmer Box .....	14
Operation .....	15
Failsafe Protections.....	15
Troubleshooting Guide.....	16
1-YEAR LIMITED WARRANTY .....	19
Warranty and Service Contact Information .....	23
FCC Information.....	23
Compliance Information for Canada.....	24
Compliance Information for the European Union.....	25

<b>Specifications</b>	<b>Cont. Current</b>	<b>LiPo Cells</b>	<b>BEC Output</b>	<b>Size/Weight</b>
SPMXAE1015	15A	2-4S LiPo	5.2V@ 3A	35x16x11mm/ 16g
SPMXAE1030	30A	3-6S LiPo	6V/ 7.2V @ 7A	56x27x13mm/ 50g
SPMXAE1045	45A	3-6S LiPo	6V/ 7.2V @ 7A	62x28x13mm/ 50g
SPMXAE1060	60A	3-6S LiPo	6V/ 7.2V @ 7A	59x31x16mm/ 56g
SPMXAE1080	80A	3-8S LiPo	6V/ 7.4V/ 8.4V @ 8A	70x35x33mm/ 145g
SPMXAE1100	100A	3-6S LiPo	6V/ 7.4V/ 8.4V @ 8A	76x35x33mm/ 126g

## Wiring Diagram

---

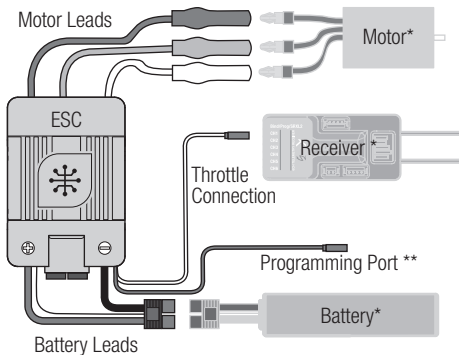

\* Not Included

\*\* Programming port located directly on ESC case on some models

## Throttle Signal

---

### **SMART Throttle\*:**

Spektrum™ Avian™ ESCs are compatible with SMART Throttle. SMART Throttle combines throttle signals with telemetry data from the ESC on one normal three-wire servo connector. SMART Throttle compatible receivers will automatically detect a SMART Throttle ESC and begin to send telemetry information to your transmitter.

Using the SMART Throttle connection, this ESC can send voltage current and other telemetry data. It can also pass along battery data from compatible Spektrum SMART batteries. A Spektrum SMART battery with an IC™ connector is required for battery data. EC™ connectors are compatible for basic operation, but will not provide SMART battery data.

Only certain Spektrum telemetry receivers include SMART Throttle; check your receiver manual for more information. If the ESC is not connected to a SMART Throttle compatible receiver, no telemetry data from the ESC will be available, but the ESC will operate normally with a common servo signal (PWM).

\*A Spektrum DSMX transmitter with telemetry is required for SMART Throttle.

### **Normal Servo Signal (PWM):**

If you plug the Avian ESC into any common RC receiver the ESC will still be compatible with a conventional servo signal for basic operation.

## Installation and Wiring

---

1. Select a location to mount the ESC with good ventilation for cooling. Mount the ESC with double sided tape or hook and loop material if mounting tabs are not included on the case.
2. Connect the three motor wires from the ESC to the motor wires in any order. In the event the motor spins the wrong direction, reverse any two wires.
3. Connect the throttle lead to the throttle channel on your receiver.
4. Secure all wiring so it is protected from damage or being caught by moving parts.

**NOTICE:** Do not connect a dedicated receiver battery to the receiver if it is connected to the ESC. When the ESC is turned On it will power the receiver with regulated voltage from the main battery through the throttle connection. The ESC may be damaged if the receiver is also connected to a dedicated receiver battery.

## ESC/Radio Calibration

---

1. Begin with the transmitter powered on at full throttle.
2. Connect a battery to the ESC. The motor will emit a series of three ascending tones.
3. The motor will emit two short tones to indicate the high throttle position has been accepted.
4. Move the throttle stick to the low position within five seconds after the two short tones.

**TIP:** If more than 5 seconds passes before you lower the throttle, the motor will motor emit another series of tones, indicating the ESC has entered programming mode.

5. The motor will emit a number of tones to indicate the number of detected LiPo cells.
6. The motor will emit one long tone to indicate the calibration is complete.

## Stick Programming

---

Power on your transmitter with the throttle at the full position.



Connect the battery to the ESC.



The motor will emit short two tones, then another series of tones to indicate the first programming parameter.



The ESC will indicate the parameter option with a series of tones.



To select a programming parameter, move the throttle stick to the bottom position within three seconds.



The motor will emit of series of tones for the selected parameter. See the Parameters Options table for details.

**TIP:** If a selection is not made the ESC will return to the beginning of the list and cycle through the options again.

**TIP:** There are twelve programming parameters. See the table below for full details.



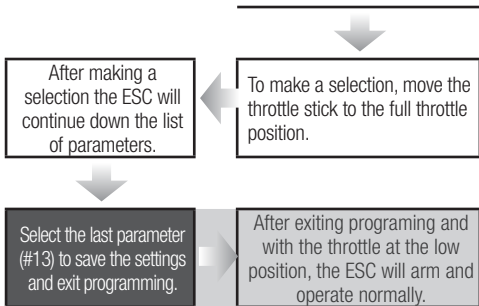

### Programming Parameters

Number of Tones	Programming Parameter
One short tone	1. Aircraft Type
Two short tones	2. Brake Type
Three short tones	3. Brake Force
Four short tones	4. Voltage Cutoff Type
One long tone	5. Number of LiPo Cells
One long tone and one short tone	6. Cutoff Voltage
One long tone and two short tones	7. BEC Voltage
One long tone and three short tones	8. Start-Up Mode
One long tone and four short tones	9. Timing
Two long tones	10. Motor Rotation
Two long tones and one short tone	11. Freewheel Mode
Two long tones and two short tones	12. Factory Reset
Two long tones and a series of short tones	13. Exit

## Parameter Options

Other programming options include the SPMXCA200 Smart Avian ESC programming box and the SmartLink USB updating and programmer application. See SpektrumRC.com for more details about Avian ESCs.

Program- ming Parameter	One short tone	Two short tones	Three short tones	Four short tones	One long tone	One long and one short tone	One long and two short tones	One long and three short tones
1. Aircraft type	Airplane	Heli- copter						
2. Brake type	Disabled	Normal	Pro- por- tional					
3. Brake force	Disabled	Level 1	Level 2	Level 3	Level 4	Level 5	Level 6	Level 7
4. Voltage Cutoff Type	Soft	Hard						
5. Number of LiPo cells	Auto Calc.	3S	4S	5S	6S			
6. Cutoff Voltage	Disabled	2.8V	3.0V	3.2V	3.4V	3.6V	3.8V	
7. BEC Voltage*	5.2V							
7. BEC Voltage**	6V	7.2V						
7. BEC Voltage***	6V	7.4V	8.4V					

8. Start-up Mode	Normal	Soft						
9. Timing	Low	Med	High					
10. Motor rotation	CW	CCW						
11. Free-wheel mode	Enabled	Dis-abled						
12. Factory Reset								
13. Exit	Exit							

7. BEC Voltage	
Avian 15A	*
Avian 30A, 45A, and 60A	**
Avian 80A, 100A	***

The blacked out cells with white text are the default settings.

## Programming Options Descriptions

### 1. Aircraft Type

- Fixed-wing: in this mode, the motor only starts up when the throttle amount reaches 5% or above and it responds to the throttle input rapidly.
- Helicopter (Governor): in this mode, the motor only starts up when the throttle amount reaches 40% or above. The motor will start up very slowly and enters the speed-governing operation after the soft start-up completes and the RPM is stable.

When changing the Aircraft Type from fixed wing mode to helicopter mode, you need to program flat throttle curves in your transmitter to define the RPM in each flight mode otherwise the speed-governing function will not work correctly.

**TIP:** Choose the “Fixed-wing” mode if your helicopter is using an external governor, disabling the Freewheel mode.

**2. Brake Type:** The throttle range changes depending on the Brake Mode

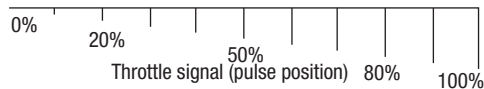
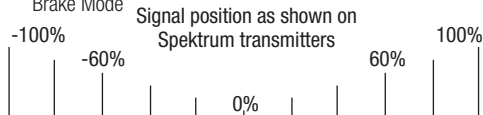

**Normal Brake**

The motor brake will activate when the throttle stick is moved to the low position. In this mode the strength of the braking is set with the Brake Force selection.

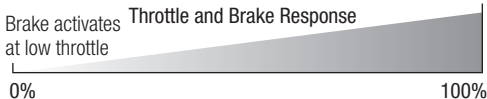
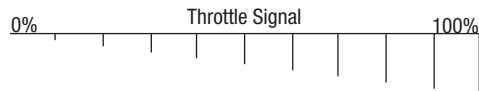

## Proportional Brake

With this option selected, the throttle range changes so the ESC will not start below 20%. The throttle will operate as normal above 20%, but moving the throttle below 20% will apply the brakes, increasing in strength as the signal drops to 0%.

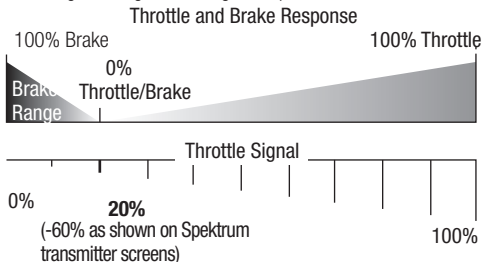

### 3. Brake Force

This option is adjustable from level 1 to level 7. The higher the level, the stronger the braking effect. Brake Force is only effective in the “Normal brake” mode.

### 4. Voltage Cutoff Type

**Soft Cutoff:** Selecting this option will gradually reduce the ESC output to 50% of the full power within 3 seconds after the low-voltage cutoff protection is activated.

**Hard Cutoff:** Selecting this option will immediately cut off the ESC output when the low-voltage cutoff protection is activated.

### 5. LiPo Cells

Select Auto Calc to cause the ESC to automatically calculate the number of LiPo cells based on a 3.7V/cell default. Alternatively, you can select a specific cell count to set the ESC to a fixed battery configuration.

## 6. Cutoff Voltage

Use this option to adjust the cutoff voltage from 2.8V to 3.8V/cell or disable the cutoff voltage completely.



**WARNING:** Discharging a LiPo battery below 2.8V/cell may damage the battery. Attempting to charge or discharge a damaged battery will cause a fire.

## 7. BEC Voltage

Select the BEC output voltage.

## 8. Start-up Mode

**Normal Start-up:** If this mode is selected, the motor will immediately increase in RPM to correspond to the throttle stick input.

**Soft Start-up:** If this mode is selected, the motor will gradually increase in RPM to correspond to the throttle stick input.

**TIP:** We recommend using this soft start-up mode when using large diameter motors or gear drives.

## 9. Timing

Select Low, Medium, or High motor timing.

## 10. Motor Rotation

Adjust the rotation direction of the motor without changing wires.

## 11. Freewheeling

This option can be set to Enabled or Disabled. Freewheeling can help provide better throttle linearity or smoother throttle response.

## Programming with the SMART Programmer Box

1. Begin with the ESC powered off.
2. Connect the programming lead to the programming port on the programming box.
3. Connect a battery to the ESC.
4. Power on the box and select the parameter with the SELECT button.
5. Change the values of the selected parameter with the EDIT button.
6. Press the SAVE button to save the changes.

## Operation

---

1. Leave the transmitter throttle at the low position and connect a battery to the ESC. The ESC will cause the motor to make several tones.  
The number of tones indicates (1) the ESC is in operation (2) the LiPo cell count detected and (3) the ESC is in a ready-to-use state.
2. Unplug the battery to turn off the ESC.

## Failsafe Protections

---

### Start-up Protection:

The ESC will monitor the motor speed during the start-up process. If the RPM of the motor is not responding as expected, the ESC will detect a start-up failure.

### In the event of a start-up failure;

- If the throttle is less than 15%, the ESC will try to restart automatically.
- If the throttle is more than 20%, the throttle stick must be moved back to the bottom position before the ESC will allow a restart.

### ESC Thermal Protection:

1. The motor will not start if the temperature exceeds 70°C when the ESC is powered on.
2. If the ESC temperature goes above 110°C during operation, the ESC will reduce the output power to 60%. This automatic power reduction helps protect the ESC from failure while still providing some power to the motor to prevent a crash. The ESC will gradually resume normal operation when the temperature drops back within the operating specifications.

### **Throttle Signal Loss Protection:**

When the ESC detects loss of signal for over 0.25 second, it will cut off power to the motor immediately. The ESC will resume normal operation when throttle signals are received.

### **Overload Protection:**

The ESC will cut off power to the motor if there is a sudden load that exceeds predetermined limits.

### **Over-current Protection:**

The ESC will cut off power to the motor if the peak current goes above the rated value.

### **Low-voltage Cutoff Protection:**

The ESC will limit the output to 60% when the input voltage drops below the LVC value.

## **Troubleshooting Guide**

<b>Problem</b>	<b>ESC Tones</b>	<b>Possible Causes</b>	<b>Solution</b>
Motor won't operate and continues to emit tones	Two short tones repeating	Input voltage is beyond the operating range of the ESC	Ensure the operating voltage is within the specs for the ESC
	One long tone repeating	The ESC is not receiving a throttle signal from the receiver	Verify the transmitter and receiver are connected, check the throttle lead is in the correct servo port, and check channel assignments
	One short tone repeating	The throttle input is not at the low position	Move the throttle control to the low position
Throttle range is set too narrow		Re-calibrate the throttle range	



<p>Motor stutters during operation above 60% throttle and continues to emit tones at low throttle</p>	<p>Two short tones repeating after operation</p>	<p>The ESC has gone over the temperature limit and activated the thermal protection feature</p>	<p>Reduce the load on the motor</p>
<p>Motor output is suddenly limited to 60% power during operation and continues to emit tones at low throttle</p>	<p>Three short tones repeating after operation</p>	<p>The voltage of the battery has dropped too low and the LVC feature has been activated.</p>	<p>Verify the battery is charged</p>
			<p>Change to a larger battery or a higher C rated battery to increase the load the battery can handle</p>
			<p>Verify the motor is not damaged; If a motor is damaged it may still function but draw excessive current, resulting in early LVC activation</p>
			<p>Reduce the load on the motor</p>

Motor stutters at start-up	N/A	Poor wiring connection between the ESC and motor	Verify all wiring connections are solid and well insulated, re-flow any cold solder joints
		Excessive drag on motor, propeller, gearbox, etc	Check for parts rubbing, bent shafts, rusted bearings, tight gears, or anything that could cause extra drag on the drive system
Motor stops during operation	N/A	ESC has activated overload or over-current protection	Verify the motor is not damaged; If a motor is damaged it may still function but draw excessive current, resulting in over current protection.
			Reduce the load on the motor
			Change to an ESC with higher current capabilities if the chosen ESC cannot handle the load demands for your model

# **1-YEAR LIMITED WARRANTY**

---

**What this Warranty Covers** - Horizon Hobby, LLC, (Horizon) warrants to the original purchaser that the product purchased (the "Product") will be free from defects in materials and workmanship for a period of 1 year from the date of purchase.

## **What is Not Covered**

This warranty is not transferable and does not cover (i) cosmetic damage, (ii) damage due to acts of God, accident, misuse, abuse, negligence, commercial use, or due to improper use, installation, operation or maintenance, (iii) modification of or to any part of the Product, (iv) attempted service by anyone other than a Horizon Hobby authorized service center, (v) Product not purchased from an authorized Horizon dealer, (vi) Product not compliant with applicable technical regulations, or (vii) use that violates any applicable laws, rules, or regulations.

OTHER THAN THE EXPRESS WARRANTY ABOVE, HORIZON MAKES NO OTHER WARRANTY OR REPRESENTATION, AND HEREBY DISCLAIMS ANY AND ALL IMPLIED WARRANTIES, INCLUDING, WITHOUT LIMITATION, THE IMPLIED WARRANTIES OF NON-INFRINGEMENT, MERCHANTABILITY AND FITNESS FOR A PARTICULAR PURPOSE. THE PURCHASER ACKNOWLEDGES THAT THEY ALONE HAVE DETERMINED THAT THE PRODUCT WILL SUITABLY MEET THE REQUIREMENTS OF THE PURCHASER'S INTENDED USE.

## **Purchaser's Remedy**

Horizon's sole obligation and purchaser's sole and exclusive remedy shall be that Horizon will, at its option, either (i) service, or (ii) replace, any Product determined by Horizon to be defective. Horizon reserves the right to inspect any and all Product(s) involved in a warranty claim. Service or replacement decisions are at the sole discretion of Horizon. Proof of purchase is required for all warranty claims. SERVICE OR REPLACEMENT AS PROVIDED UNDER THIS WARRANTY IS THE PURCHASER'S SOLE AND EXCLUSIVE REMEDY.

## **Limitation of Liability**

HORIZON SHALL NOT BE LIABLE FOR SPECIAL, INDIRECT, INCIDENTAL OR CONSEQUENTIAL DAMAGES, LOSS OF PROFITS OR PRODUCTION OR COMMERCIAL LOSS IN ANY WAY, REGARDLESS OF WHETHER SUCH CLAIM IS BASED IN CONTRACT, WARRANTY, TORT, NEGLIGENCE, STRICT LIABILITY OR ANY OTHER THEORY OF LIABILITY, EVEN IF HORIZON HAS BEEN ADVISED OF THE POSSIBILITY OF SUCH DAMAGES. Further, in no event shall the liability of Horizon exceed the individual price of the Product on which liability is asserted. As Horizon has no control over use, setup, final assembly, modification or misuse, no liability shall be assumed nor accepted for any resulting damage or injury. By the act of use, setup or assembly, the user accepts all resulting liability. If you as the purchaser or user are not prepared to accept the liability associated with the use of the Product, purchaser is advised to return the Product immediately in new and unused condition to the place of purchase.

## **Law**

These terms are governed by Illinois law (without regard to conflict of law principals). This warranty gives you specific legal rights, and you may also have other rights which vary from state to state. Horizon reserves the right to change or modify this warranty at any time without notice.

## **WARRANTY SERVICES**

### **Questions, Assistance, and Services**

Your local hobby store and/or place of purchase cannot provide warranty support or service. Once assembly, setup or use of the Product has been started, you must contact your local distributor or Horizon directly. This will enable Horizon to better answer your questions and service you in the event that you may need any assistance. For questions or assistance, please visit our website at [www.horizonhobby.com](http://www.horizonhobby.com), submit a Product Support Inquiry, or call the toll free telephone number referenced in the Warranty and Service Contact Information section to speak with a Product Support representative.

## **Inspection or Services**

If this Product needs to be inspected or serviced and is compliant in the country you live and use the Product in, please use the Horizon Online Service Request submission process found on our website or call Horizon to obtain a Return Merchandise Authorization (RMA) number. Pack the Product securely using a shipping carton. Please note that original boxes may be included, but are not designed to withstand the rigors of shipping without additional protection. Ship via a carrier that provides tracking and insurance for lost or damaged parcels, as Horizon is not responsible for merchandise until it arrives and is accepted at our facility. An Online Service Request is available at [http://www.horizonhobby.com/content/service-center\\_render-service-center](http://www.horizonhobby.com/content/service-center_render-service-center). If you do not have internet access, please contact Horizon Product Support to obtain a RMA number along with instructions for submitting your product for service. When calling Horizon, you will be asked to provide your complete name, street address, email address and phone number where you can be reached during business hours. When sending product into Horizon, please include your RMA number, a list of the included items, and a brief summary of the problem. A copy of your original sales receipt must be included for warranty consideration. Be sure your name, address, and RMA number are clearly written on the outside of the shipping carton.

**NOTICE: Do not ship LiPo batteries to Horizon. If you have any issue with a LiPo battery, please contact the appropriate Horizon Product Support office.**

## **Warranty Requirements**

For Warranty consideration, you must include your original sales receipt verifying the proof-of-purchase date. Provided warranty conditions have been met, your Product will be serviced or replaced free of charge. Service or replacement decisions are at the sole discretion of Horizon.

## **Non-Warranty Service**

Should your service not be covered by warranty, service will be completed and payment will be required without notification or estimate of the expense unless the expense exceeds 50% of the retail purchase cost. By submitting the item for service you are agreeing to payment of the service without notification. Service estimates are available upon request. You must include this request with your item submitted for service. Non-warranty service estimates will be billed a minimum of ½ hour of labor. In addition you will be billed for return freight. Horizon accepts money orders and cashier's checks, as well as Visa, MasterCard, American Express, and Discover cards. By submitting any item to Horizon for service, you are agreeing to Horizon's Terms and Conditions found on our website [http://www.horizonhobby.com/content/service-center\\_render-service-center](http://www.horizonhobby.com/content/service-center_render-service-center).

**ATTENTION: Horizon service is limited to Product compliant in the country of use and ownership. If received, a non-compliant Product will not be serviced. Further, the sender will be responsible for arranging return shipment of the un-serviced Product, through a carrier of the sender's choice and at the sender's expense. Horizon will hold non-compliant Product for a period of 60 days from notification, after which it will be discarded.**

10/15

## Warranty and Service Contact Information

Country of Purchase	Horizon Hobby	Contact Information	Address
United States of America	Horizon Service Center (Repairs and Repair Requests)	servicecenter.horizonhobby.com/ RequestForm/	2904 Research Rd. Champaign, Illinois, 61822 USA
	Horizon Product Support (Product Technical Assistance)	productsupport@horizonhobby.com.	
		877-504-0233	
	Sales	websales@horizonhobby.com	
800-338-4639			

## FCC Information

### Supplier's Declaration of Conformity

Spektrum 15 Amp Avian ESC– SPMXAE1015

Spektrum 30 Amp Avian ESC– SPMXAE1030

Spektrum 45 Amp Avian ESC– SPMXAE1045

Spektrum 60 Amp Avian ESC– SPMXAE1060

Spektrum 80 Amp Avian ESC– SPMXAE1080

Spektrum 100 Amp Avian ESC– SPMXAE1100

 This device complies with part 15 of the FCC Rules. Operation is subject to the following two conditions:

(1) This device may not cause harmful interference, and (2) this device must accept any interference received, including interference that may cause undesired operation.



**CAUTION:** changes or modifications not expressly approved by the party responsible for compliance could void the user's authority to operate the equipment.

**NOTE:** This equipment has been tested and found to comply with the limits for a Class B digital device, pursuant to part 15 of the FCC Rules. These limits are designed to provide

reasonable protection against harmful interference in a residential installation. This equipment generates, uses and can radiate radio frequency energy and, if not installed and used in accordance with the instructions, may cause harmful interference to radio communications. However, there is no guarantee that interference will not occur in a particular installation. If this equipment does cause harmful interference to radio or television reception, which can be determined by turning the equipment off and on, the user is encouraged to try to correct the interference by one or more of the following measures:

- Reorient or relocate the receiving antenna.
- Increase the separation between the equipment and receiver.
- Connect the equipment into an outlet on a circuit different from that to which the receiver is connected.
- Consult the dealer or an experienced radio/TV technician for help.

Horizon Hobby, LLC

2904 Research Rd.,

Champaign, IL 61822

Email: [compliance@horizonhobby.com](mailto:compliance@horizonhobby.com)

Web: [HorizonHobby.com](http://HorizonHobby.com)

## **Compliance Information for Canada**

---

CAN ICES-3 (B)/NMB-3(B)

This device complies with Industry Canada licence-exempt RSS standard(s).

Operation is subject to the following two conditions:

(1) this device may not cause interference,

(2) this device must accept any interference, including interference that may cause undesired operation of the device.



## Compliance Information for the European Union

**CE** **EU Compliance Statement:** SPMXAE1015, SPMXAE1030, SPMXAE1045, SPMXAE1060, SPMXAE1080, SPMXAE1100

Horizon Hobby, LLC hereby declares that this product is in compliance with the essential requirements and other relevant provisions of the EMC Directive.

A copy of the EU Declaration of Conformity is available online at:

<http://www.horizonhobby.com/content/support-render-compliance>.

### **Instructions for disposal of WEEE by users in the European Union**



This product must not be disposed of with other waste. Instead, it is the user's responsibility to dispose of their waste equipment by handing it over to a designated collection point for the recycling of waste electrical and electronic equipment. The separate collection

and recycling of your waste equipment at the time of disposal will help to conserve natural resources and make sure that it is recycled in a manner that protects human health and the environment. For more information about where you can drop off your waste equipment for recycling, please contact your local city office, your household waste disposal service or where you purchased the product.

# AVIAN™

© 2019 Horizon Hobby, LLC. Avian, the Avian Logo, IC3, EC3, the Smart Technology logo, and the Horizon Hobby logo are trademarks or registered trademarks of Horizon Hobby, LLC.

The Spektrum trademark is used with permission of Bachmann Industries, Inc.

All other trademarks, service marks and logos are property of their respective owners.

SPMXAE1015, SPMXAE1030, SPMXAE1045, SPMXAE1060,  
SPMXAE1100

Created 08/2019

60592.1